



SUITE
PLANTS



CONCERGE COMMONS
GALLERIA ELEVATORS

Our intelligently engineered living wall systems can fit almost any wall location, size, or shape.



Nuremberg, Germany

TABLE OF CONTENTS



LIVEPANEL



LIVEPICTUREGO



LIVEPICTURE



LIVEDIVIDER



LIVEHEDGE



PRESERVED MOSS



ARTIFICIAL PANELS



EVENT WALL KITS

LIVEPANEL PRODUCT FEATURES



Easy Installation

No waterproofing or structural reinforcements required to install hardware



Smart & Safe Watering

Passive irrigation system utilizes natural capillary wicking, which is much more reliable than pumps, drip irrigation lines or catch basins



Lightweight & Slim

Only 8 lb/sqft when fully loaded with plants and water. Protrudes only 3.75" from the wall.



Healthy Plants

Plants can grow throughout the cassette (i.e. not contained to their grow pots), producing a vibrant living wall



Huntersville, North Carolina

STREAMLINED PROCESS

1

Initial Consultation

- Review project criteria such as timeline, size, budget, design goals, etc.

2

Design Phase

- Select a living wall that fits both your budget and design goals
- Determine plant pattern, irrigation method, and supplemental lighting needs

3

Pre-Installation

- Shop drawing(s), field measurements, MEP documents, etc.
- Source plants and start pre-growing in greenhouses

4

Installation

- LIVEPANEL hardware installed on site
- Coordinate with MEP trades for irrigation and lighting
- After irrigation and lighting are tested successfully, plants arrive on site to be installed

5

Maintenance

- Every green wall requires ongoing plant maintenance
- Nationwide network of experienced plant maintenance providers
- Hardware and plant warranty



Denver, Colorado

LIVEPANEL FEATURES

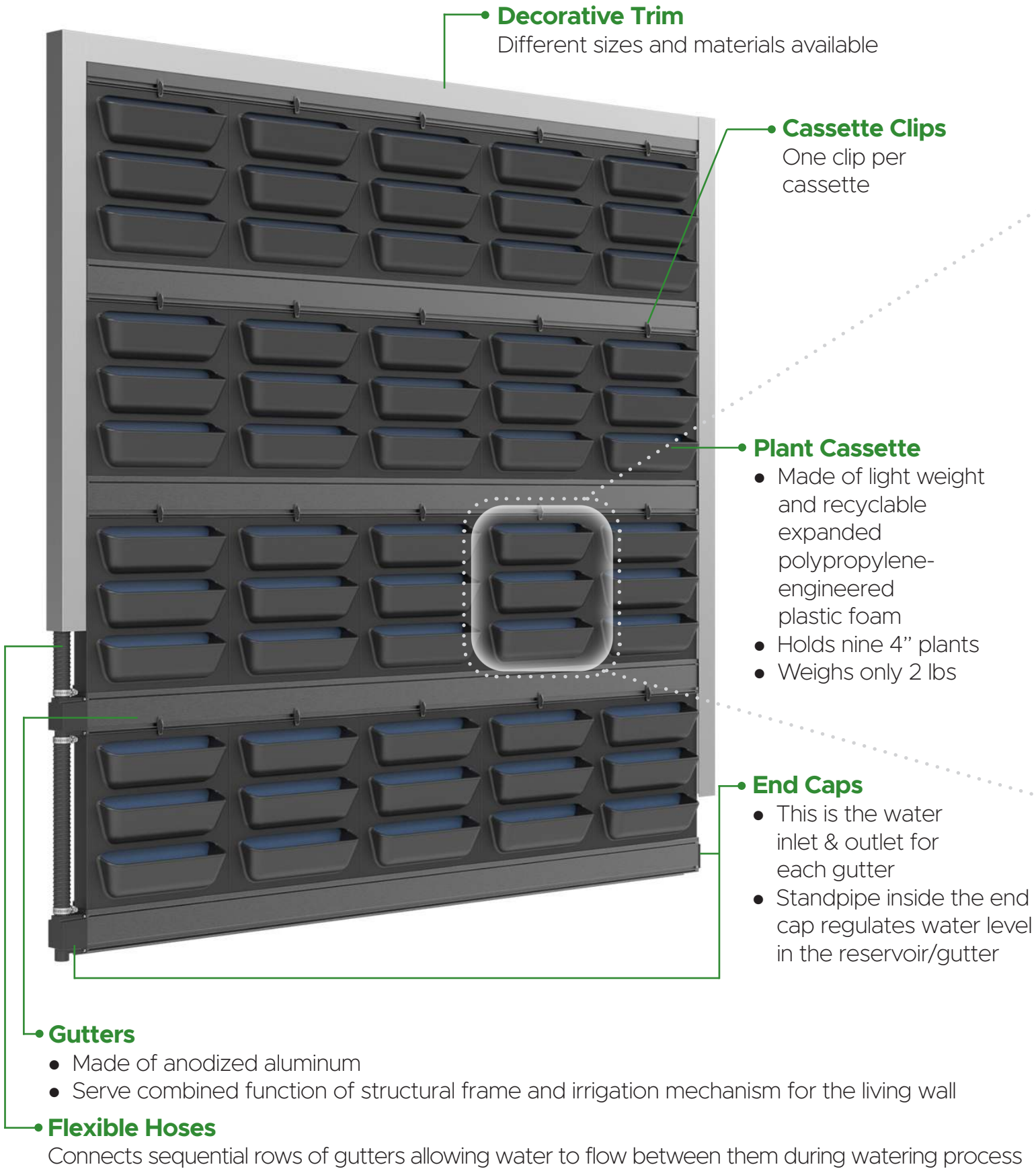

**all walls are custom built to specification*

PLANT CASSETTE DETAILS

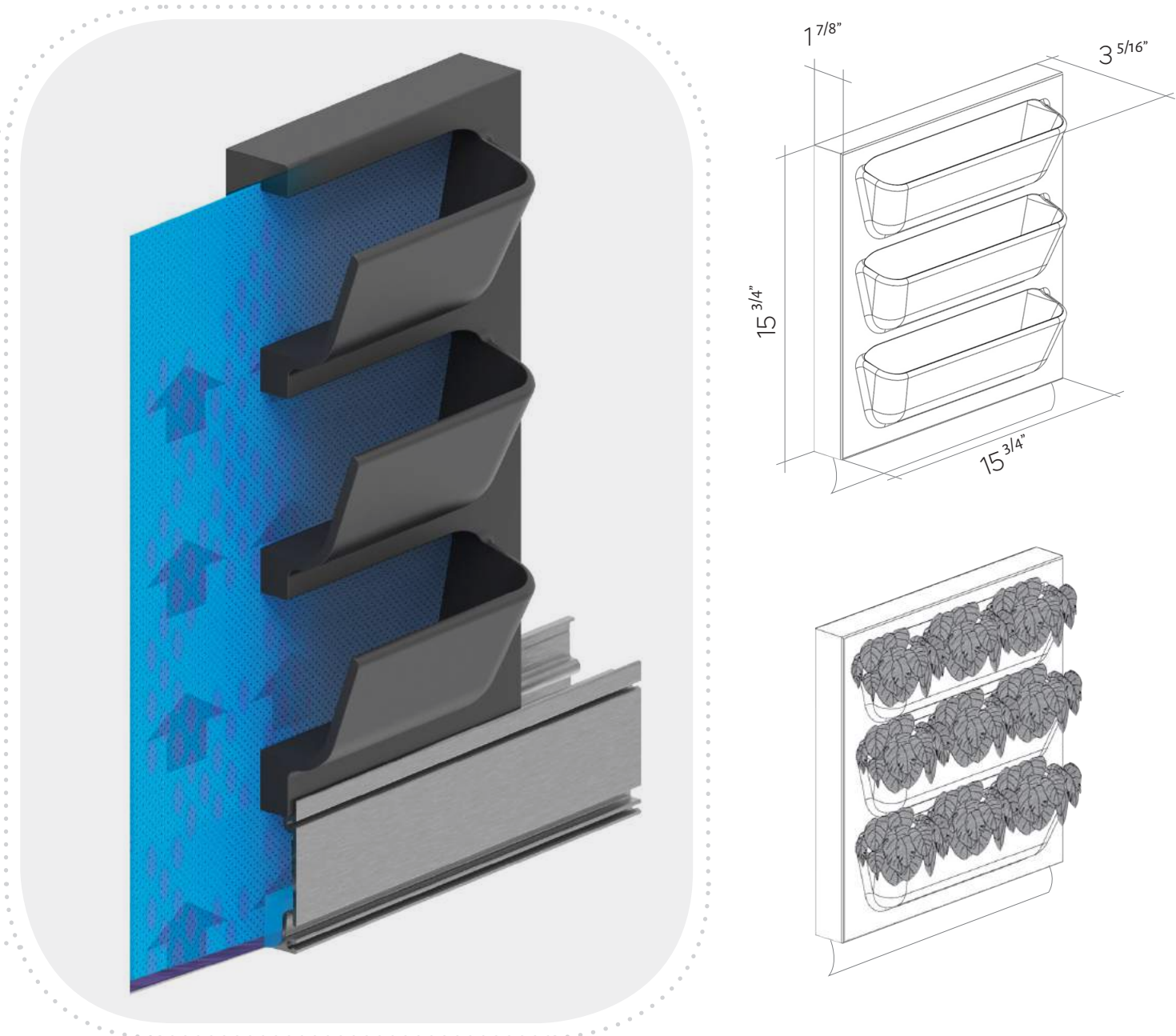

IRRIGATION



All plants need water. There are many different possible irrigation methods. Selecting the right one for your project depends on the size of the green wall, accessibility, location, and budget. LIVEPANEL green walls can be manually or automatically watered.

Manual Irrigation



Portable Water Tank

- Only for small and easily accessible walls
- Can use a catch basin for manual drainage
 - + No upfront costs for plumbing, drainage or electricity
 - Ongoing maintenance costs may be higher
 - Possibility for human error



Hose Connection

- Can be a temporary hose or a hard line plumbing pipe with an on/off valve
- Can use a catch basin for manual drainage
 - + Low or zero upfront costs for plumbing, drainage and electricity
 - Ongoing maintenance costs may be higher
 - Possibility for human error

Automatic Irrigation

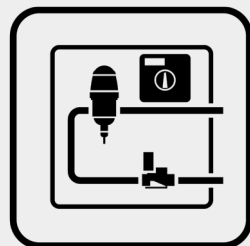

Irrigation Control Unit (ICU)

- Programmable irrigation unit with optional fertilizer injection
- Requires water supply and drainage connections to buildings' plumbing
 - + Ensures plants always have water
 - + Lower ongoing maintenance costs
 - Additional upfront costs for plumbing, drainage and electricity

LIVEPANEL INSTALLATION WITH ICU

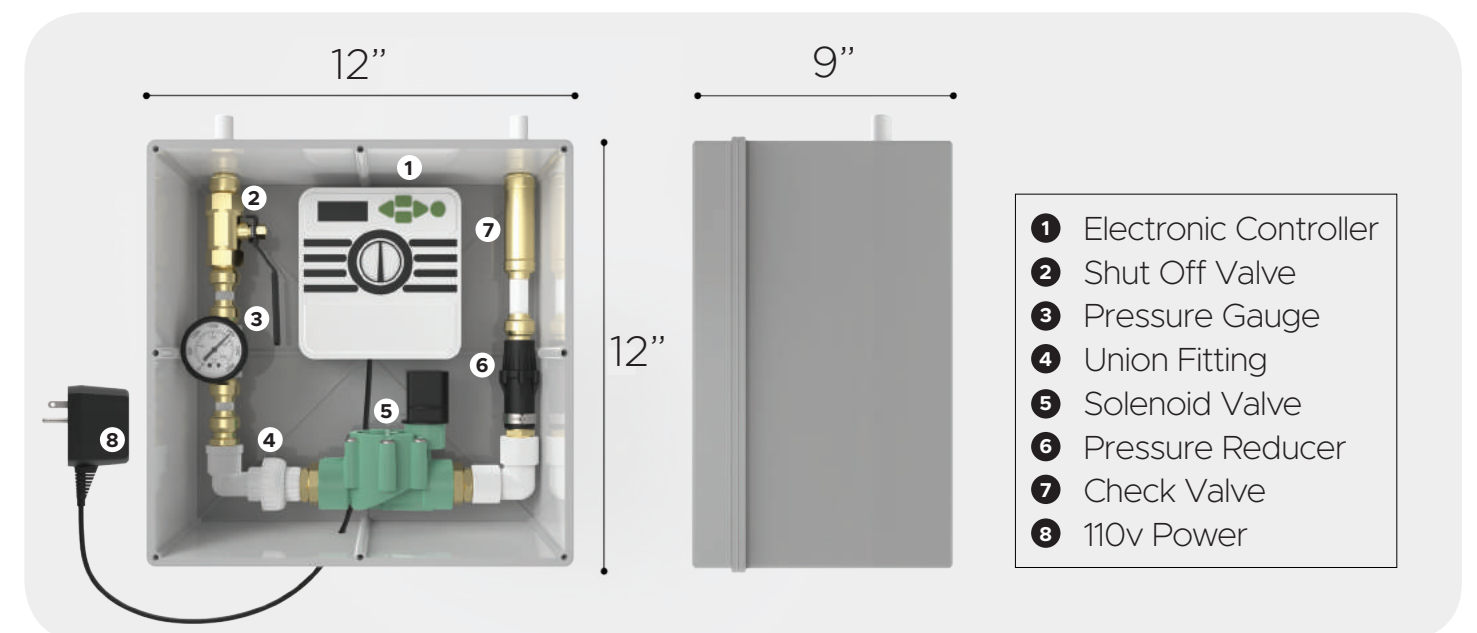
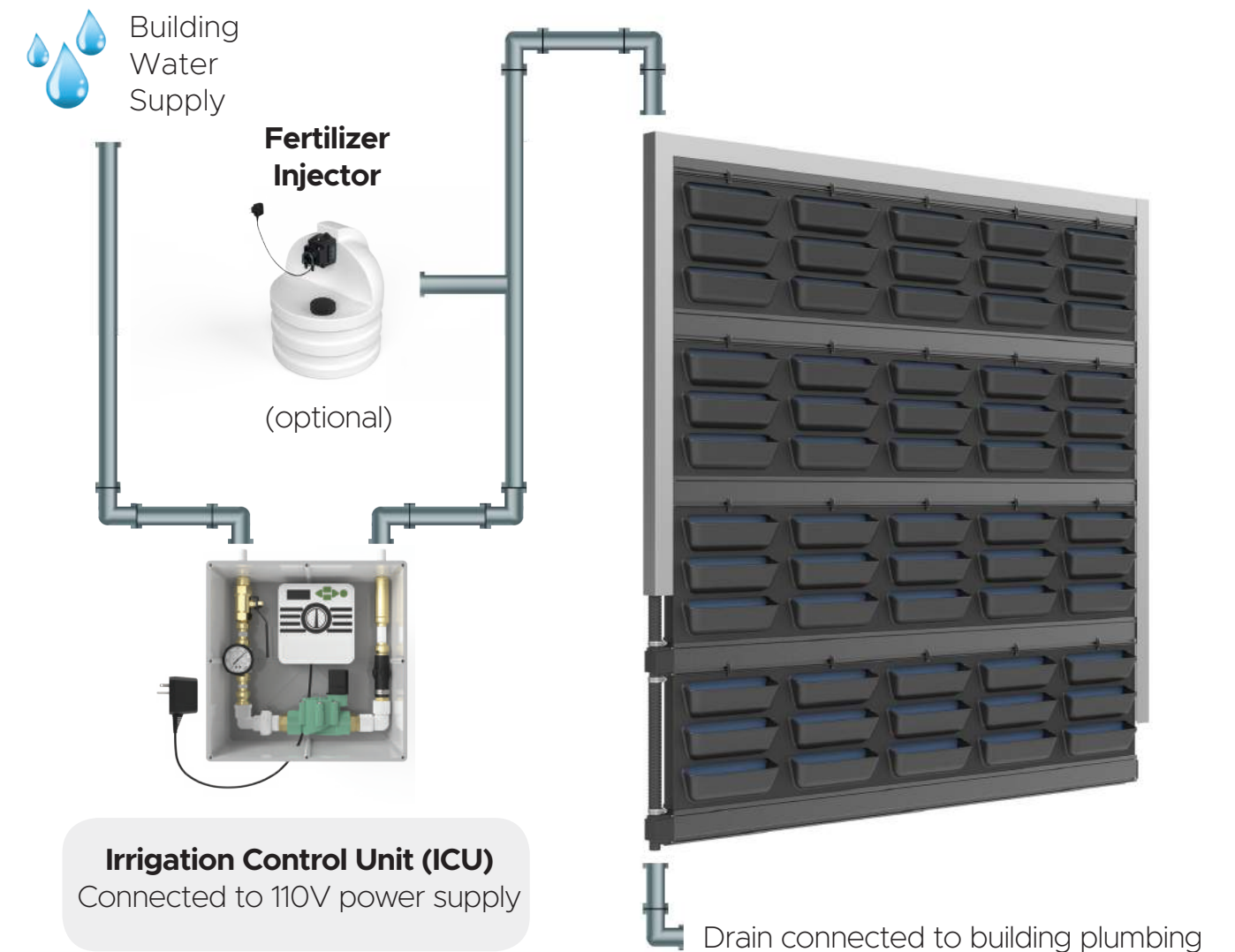

TRIM OPTIONS

No Trim

Silver - Aluminum

Black - Textured Plastic



MODIFICATIONS

Plant Cassettes can be cut into one-third pieces, both horizontally and vertically. LIVEPANEL can get within +/-5" for any specified green wall length or width.

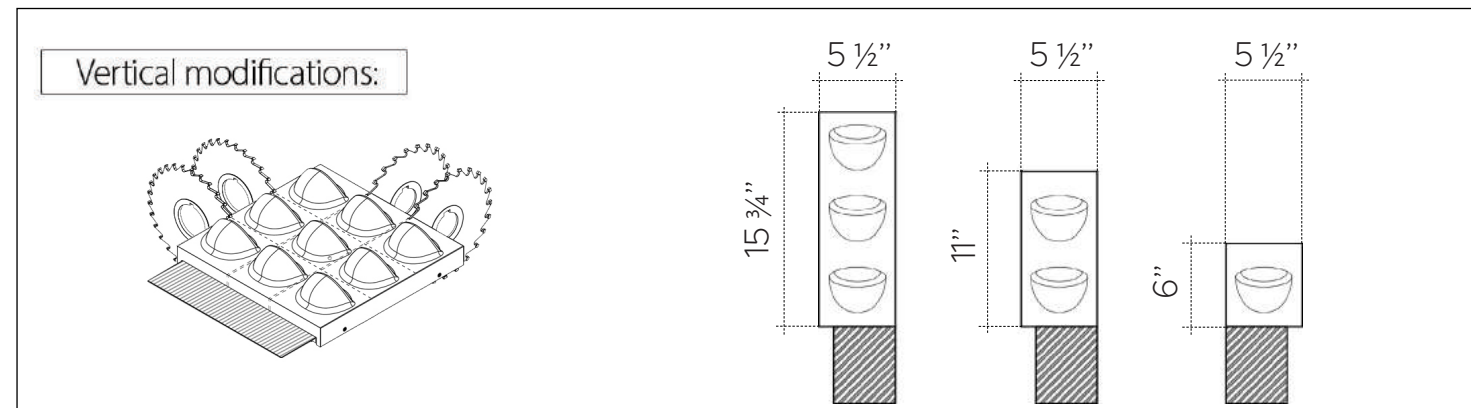
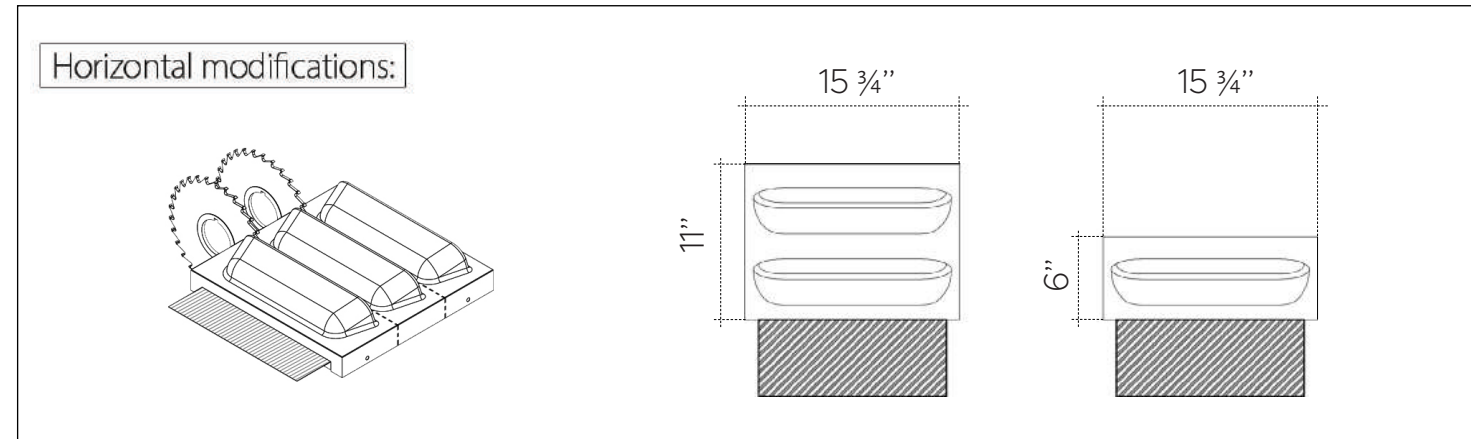

TYPICAL INSTALLATION DETAIL

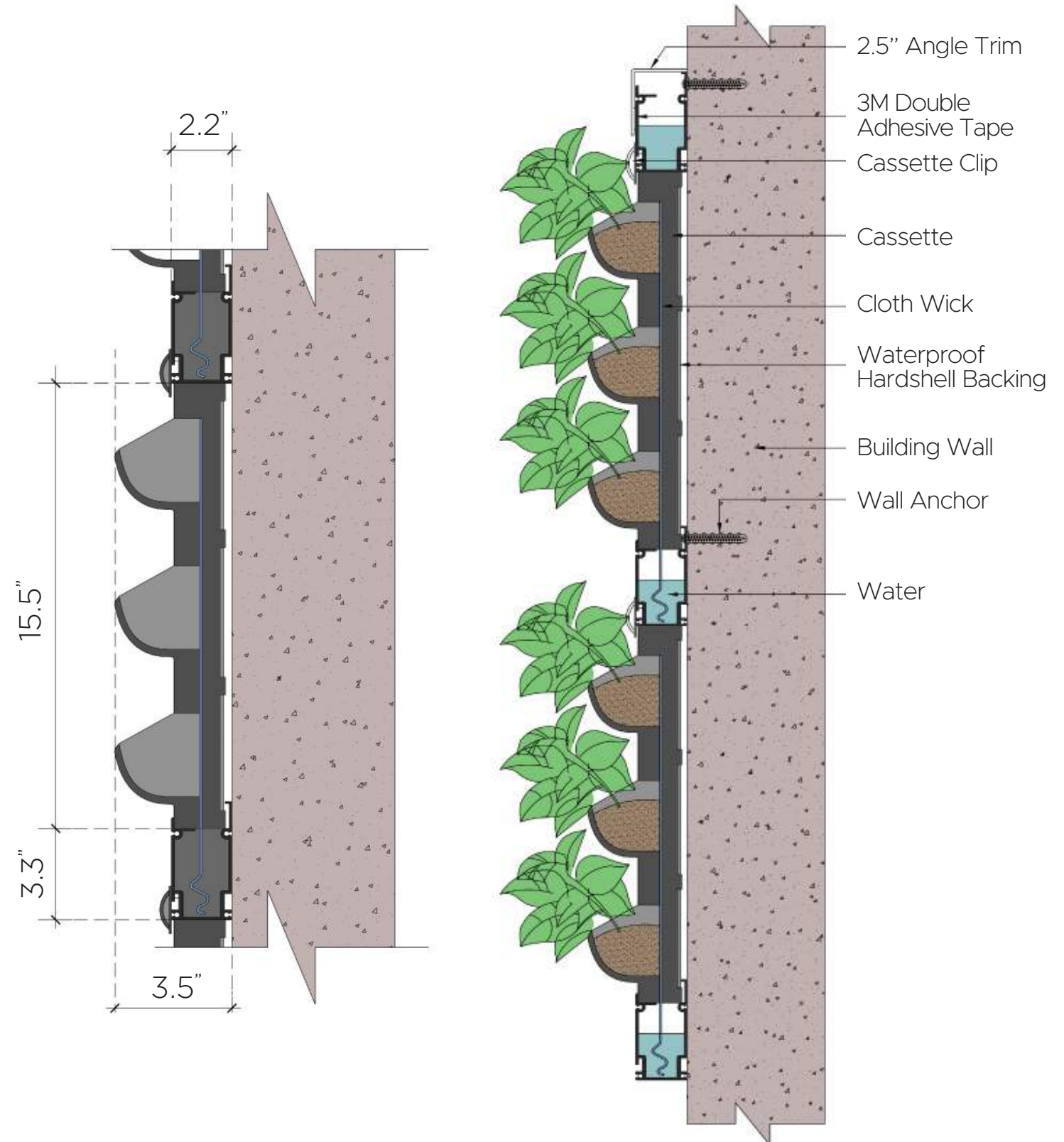



RECOMMENDED GREEN WALL LED LIGHTING FIXTURES



A minimum of 150 foot candles of light measurable at any point on the green wall surface is recommended. Supplemental lighting may be required. A photometric analysis, taking seasonal lighting changes into account, should be completed to confirm that specified light fixtures will be sufficient.



	Track Lighting		Recessed Lighting		Other
					
Model	Eaton L806HO		Phillips LLAB3-VA 39W		Sunlite ST30Y48M10X6R
Color Temperature	4000K		4000K		5500K
Bulb Type: Up to 3' Distance	25 Degree Narrow Flood		23 Degree Narrow Flood		LED light bar available in 12"-96" lengths
Bulb Type: 3-6'	11 Degree Spot		8 Degree Narrow Spot		
Bulb Type: >6'	Call Suite Plants		Call Suite Plants		
Cost	\$275 (includes 8' track)		\$285 (includes 8' track)		~\$100 per 12" length



CONCERGE
COMMONS

Columbus, Ohio



Venice Beach, California



Fort Lauderdale, Florida



Pittsburgh, Pennsylvania



Denver, Colorado

CHIC & COMPACT LIVEPICTUREGO

Side View



Front View



- **Sizable** – Holds 4-6 plants
- **Simple** – Easy to install and maintain
- **Smart** – Watering can indicator lets you know when it's time to add more water (holds 1-2 weeks)



Available colors: white red charcoal black

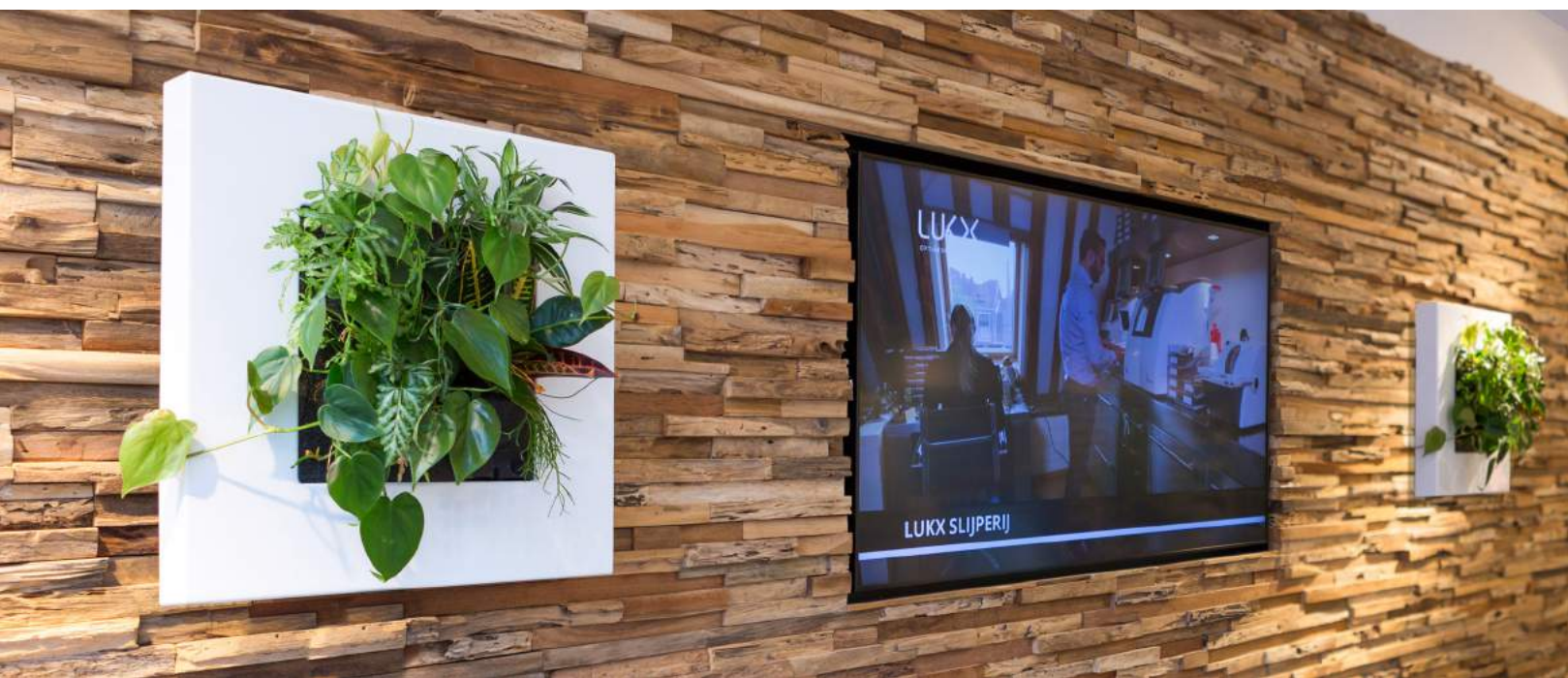



LIVING ARTWORK

LIVEPICTURE



- **Simple:** Hangs on the wall as easily as a painting; no electricity needed
- **Easy:** Water tanks behind the frame hold 4-6 weeks of water
- **Branding Opportunity:** Custom graphic or logos can be added to the frames

Available colors: charcoal white silver





FREESTANDING LIVING WALL

LIVEDIVIDER

- **Doesn't Require Any Electricity** and the integrated watering system holds 4+ weeks of water
- **Holds Plants On Both Sides** and comes with a solid base



Available colors:

silver

white*

* special order





BIO FENCING

LIVEHEDGE

- **Instant Greenery & Privacy** - Pre-grown trellis create a visual barrier with plants
- **Any Size** - Trellis is fabricated to meet your exact specification
- **Plants Thrive** - Plant species carefully selected to match your climate
- **Flexible Installation** - Trellises can be planted directly into the ground or into a planter box



MUMMY PLANTS

PRESERVED MOSS

- **Unique** – Offers a completely different look than plant walls
- **Simplicity** – Easy to install and do not require any water, light or maintenance
- **Flexibility** - Can be made in any shape, including intricate corporate logos

Available varieties:

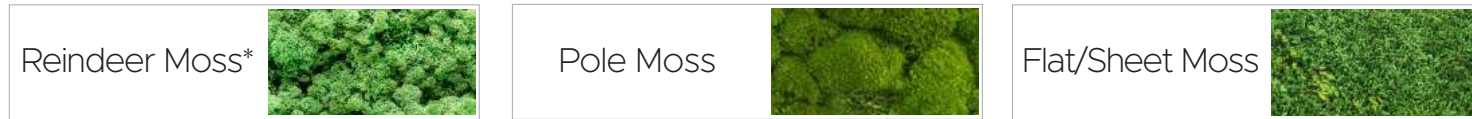

*available in 20 colors

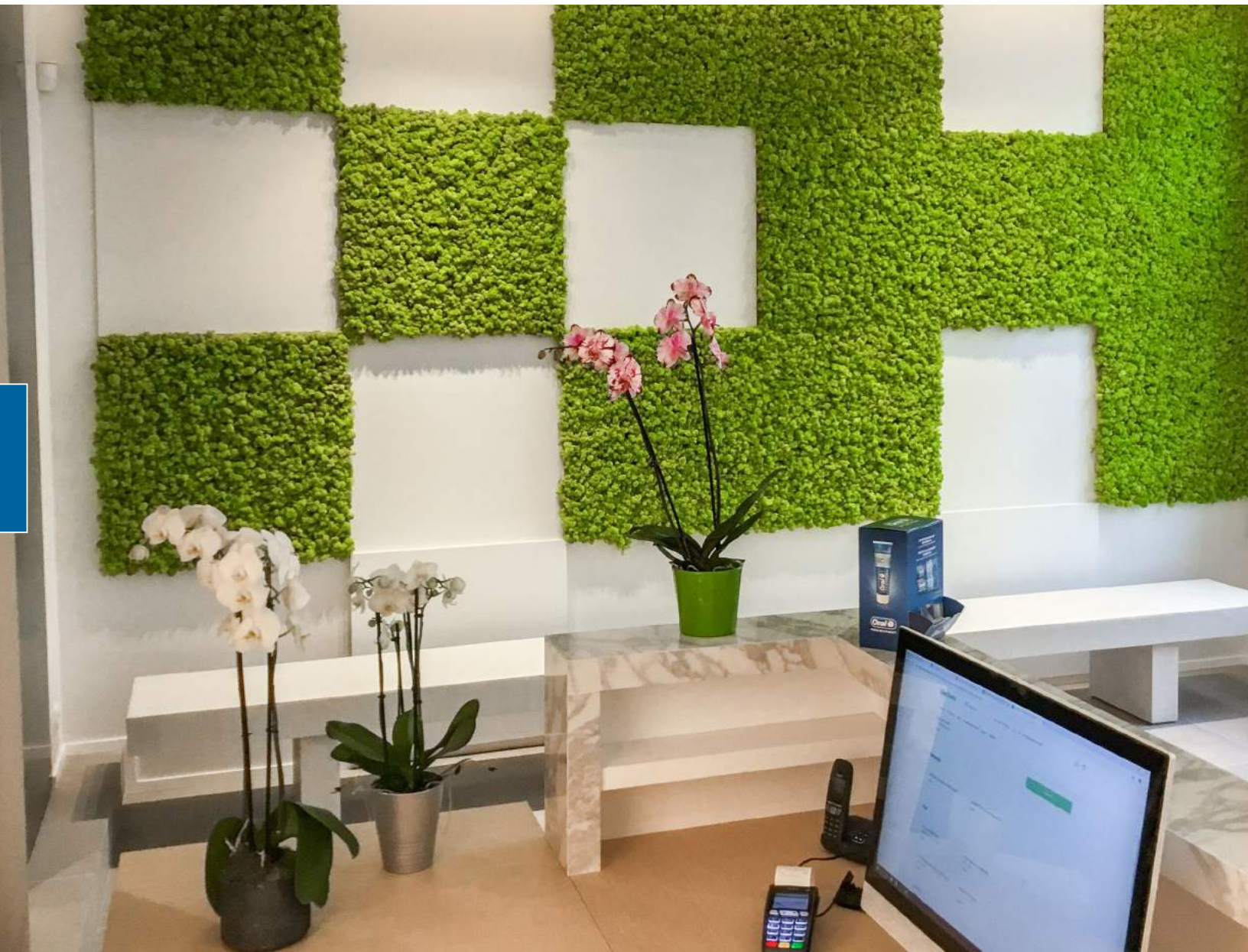



Charlotte, North Carolina

ZERO MAINTENANCE

ARTIFICIAL PANELS

- **Lifelike** – Ultra-realistic artificial plants mimic nature’s beauty
- **Versatile** – Overcomes complex design challenges (no light, limited access, harsh environments, etc.)
- **Practical** – Year-round greenery for a fraction of the cost and without any need for maintenance

Available in 2 Base Panel Options:

Leafy Green
for indoor or
short-term
applications



Lush Green
UV-rated/fire
retardant,
suitable for
long-term
outdoor
applications



Choose between 12 color accent plants to customize your wall

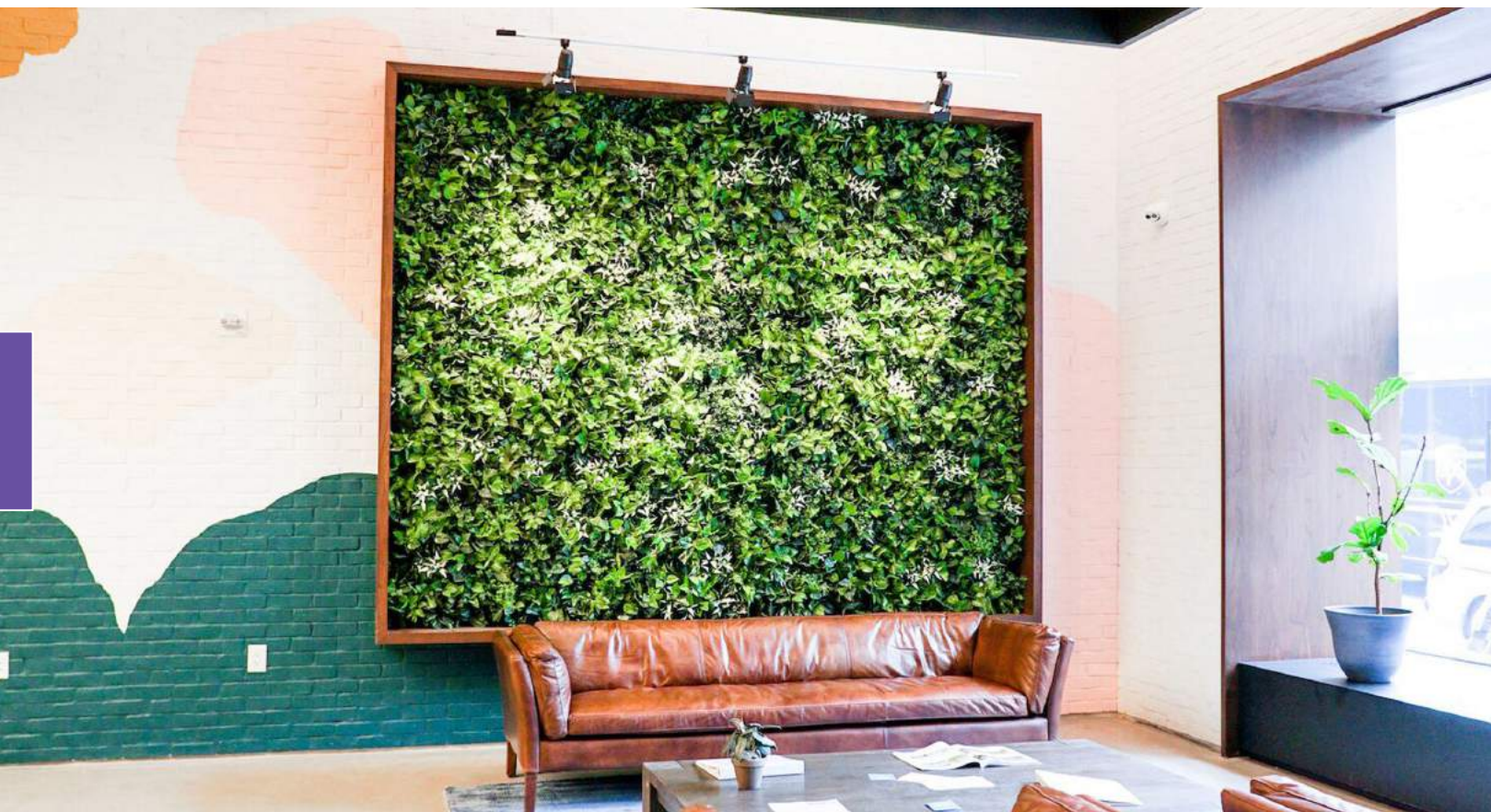

Before

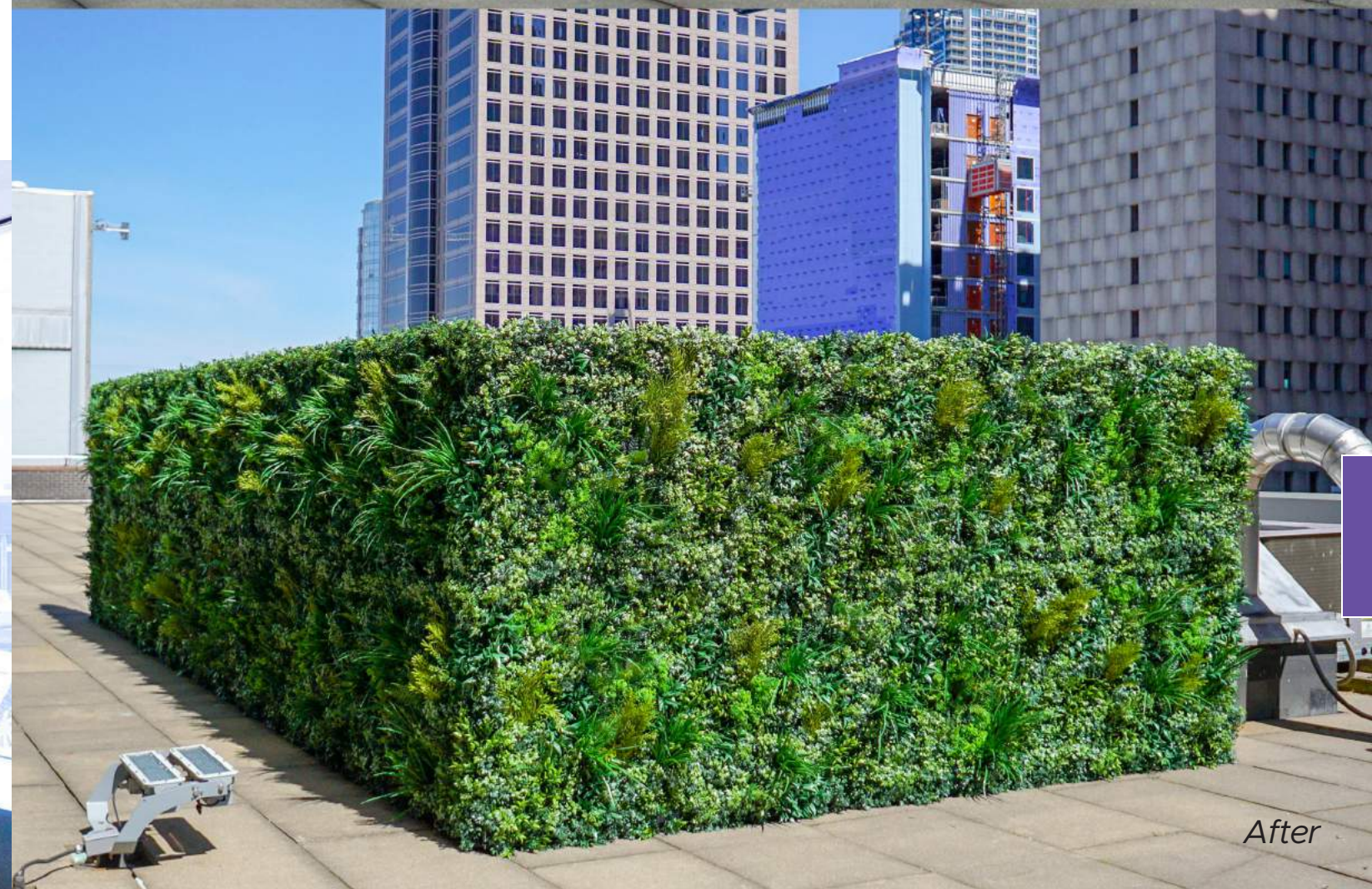

After



Jersey City, New Jersey

PICTURE PERFECT







EVENT WALL KITS

Made up of our lifelike artificial panels this 9' x 9' wall is a great asset for your next event to help achieve those Instagram worthy photos.

- **Quick** – Create a beautiful green wall in under 30 minutes
- **Personalized** – Custom signage available
- **Captivating** – Ideal backdrop, guaranteed to encourage photography and social media sharing





Prefabricated products	Colors	SKU	Number of 4" plants	Size (HxWxD)	Weight		Water Capacity
					Empty	Full	
LIVEPICTURE GO 	White Black Red Charcoal	LP-G-W LP-G-B LP-G-R LP-G-C	4	20.3"x20.3x4.4"	6 lb	+/- 12lbs	0.5 gal
LIVEPICTURE I 	Silver White Charcoal	LP-1-S LP-1-W LP-1-C	9	28.5"x28.5x2.75"	26.5 lb	61.9 lb	3.7 gal
LIVEPICTURE II 	Silver White Charcoal	LP-2-S LP-2-W LP-2-C	18	28.5"x44.5x2.75"	36.5 lb	87.4 lb	5.0 gal
LIVEPICTURE III 	Silver White Charcoal	LP-3-S LP-3-W LP-3-C	27	28.5"x60"x2.75"	46.5 lb	112.4 lb	6.3 gal
LIVEPICTURE IV 	Silver White Charcoal	LP-4-S LP-4-W LP-4-C	36	28.5"x76"x2.75"	56 lb	137.9 lb	7.7 gal
LIVEPICTURE XL 	Silver White*	LP-XL-S LP-XL-W	54	67"x44.5"x2.75"	77 lb	187.8 lb	10.0 gal
LIVEDIVIDER 	Silver White*	LD-2-S LD-2-W	108	71"x44.5x5.5"	282 lb	443.8 lb	20.3 gal

* Available upon request (please allow extra time for delivery)

Custom Green Wall Systems



LIVEPANEL



Moss



Artificial Living Wall

Custom Trellises and Planter Boxes



Fabricated to meet any size or specifications. Selection of different materials, colors, and vining plants available. Call for product pricing

Maintenance & Light Solutions



LIVEPICTURE Light



Fertilizer Kit



SunLite LED Bar



LIVEPICTURE Funnel



Light Meter



Irrigation Control Unit
w/ fertilizer injector system

Miscellaneous Items & Extra Parts



Moss Sample Box



Cassette



Cassette Clip



Filler blocks



SUITE PLANTS

Charlotte, North Carolina

(855) 275-8111

info@suiteplants.com

www.SuitePlants.com